

CONTEMPORARY PREP SIZE PLP PULLDOWN FAUCET / 2PC. SUITE

5910-2

- MAX COUNTER THICKNESS 2-3/8"
- MINIMUM INSTALL HOLE SIZE 1-1/2"

- A. *Spray Connection with 3/8" Compression Fitting*
- B. *Supply Hoses - 20" Long with 3/8" Compression Fittings*

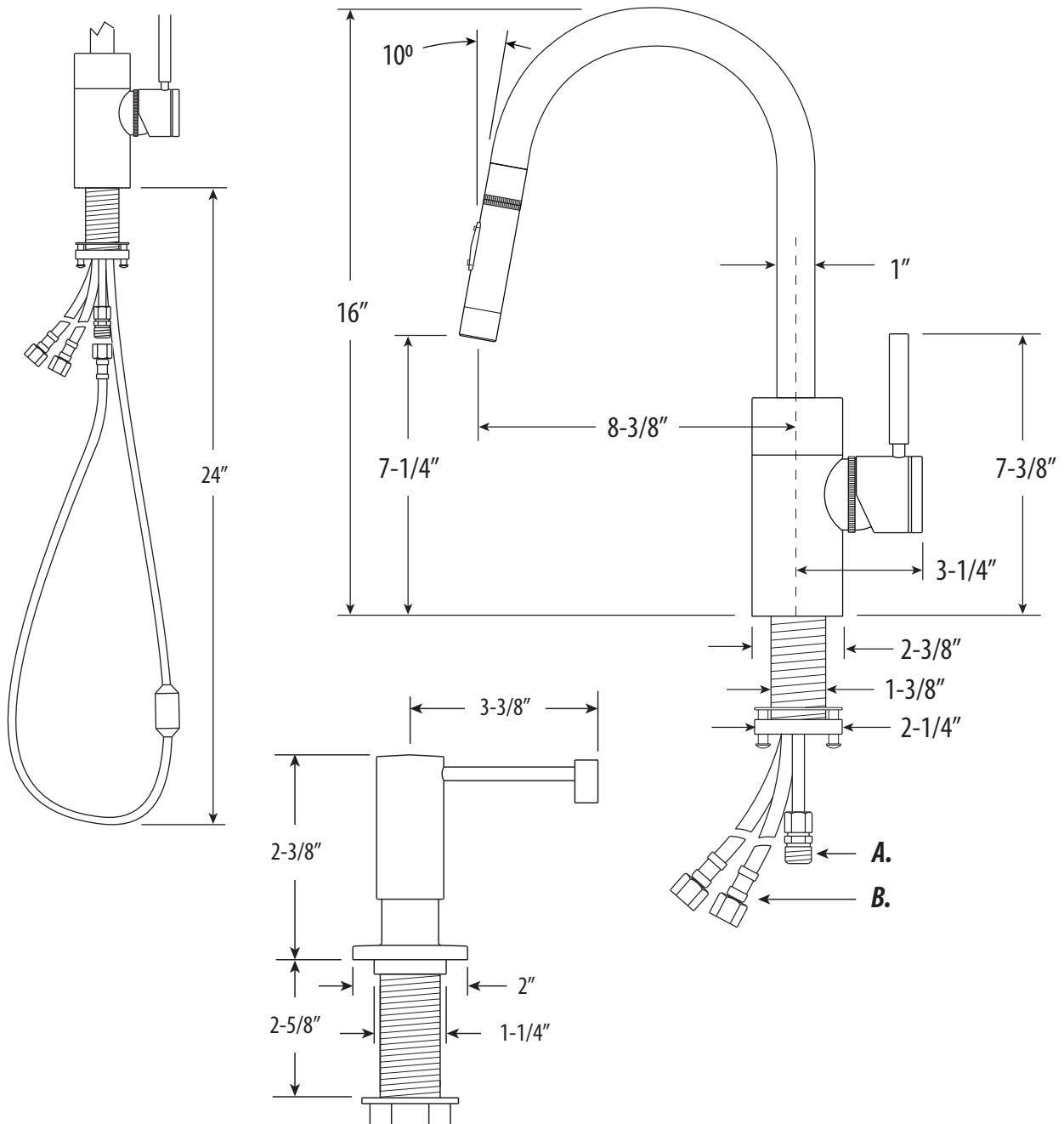

DIMENSIONS MAY VARY AND ARE SUBJECT TO CHANGE. NO RESPONSIBILITY IS ASSUMED FOR USE OF SUPERCEDED OR VOIDED DATA

