



# BLD112-2

COCO SQUARE SMOOTH BUILDER'S SERIES

### DETAILS

Materials: Copper, Brass, or Stainless Steel





Installation Type: Drop-In or Undermount

2" Drain Opening, No Overflow

Each sink is hand-crafted; no two sinks will be the same

NOTE: Due to the handmade nature of the sink, dimensions are approximate and variations in the metal may be visible.

### AVAILABLE FINISHES

	<b>UB</b>	Satin Unlacquered Brass
	<b>PB</b>	Polished Unlacquered Brass
	<b>SS</b>	Satin Stainless Steel
	<b>PS</b>	Polished Stainless Steel

### AVAILABLE DRAINS

		<b>D001</b>	2" Bar Drain
---	--	-------------	--------------

### INSTALLATION

Drain should be installed first.

**DROP-IN:** Cut opening large enough for the sink to be "dropped in" to countertop. **UNDERMOUNT:** Use actual sink for templating. Cuts in countertop are up to the discretion of the installer. Clips or other installation method must be provided by the fabricator/installer. Use silicone adhesive to adhere sink to countertop. Clean any excess silicone from sink surface to avoid damaging the finish.

### CARE

This sink has a living finish (excluding SS/PS), which will change with time and use. Use mild soap and water for everyday cleaning. Avoid any harsh abrasives, acidic cleaning products, and antibacterial hand soap. A paste wax may be applied periodically to protect the finish and help with water spotting.

### WARRANTY

Linkasink warranties our product to be free from manufacturing defect for the life of the product. Warranty does not cover improper care or abuse/neglect, or changes to the living finish.

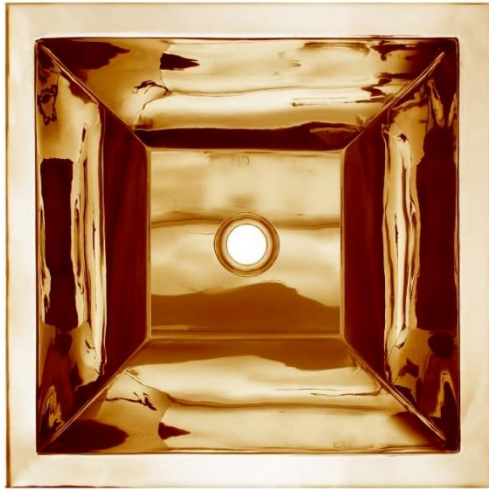

Shown in PB

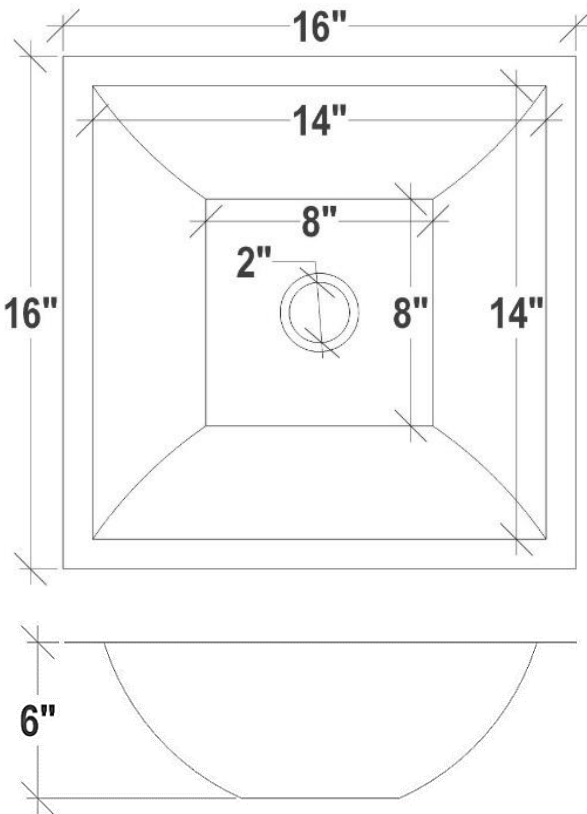
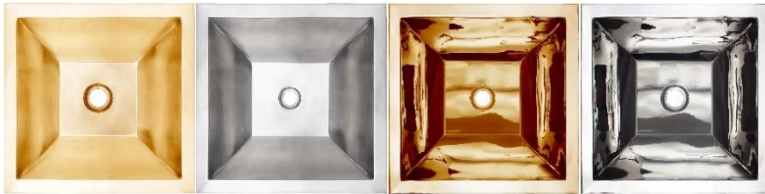

### DIMENSIONS WILL VARY

**DO NOT** use this sheet as a guide for countertop cuts. Due to the handmade nature of each product, templates are not provided.