

SHOWER
Finezza DUE M-Series
Thermostatic Shower System -
Shower with Handshower
GR3.011WB-C15E0

GRAFF®



Information

- 3/4" thermostatic valve and trim
- 3/4" stop/volume control valve (2 pieces)
- 9" showerhead with 12" ceiling-mounted shower arm
- Showerhead features no-clog, easy-clean spray nozzles
- Handshower set with wall-mounted slide bar and 59" hose (PVD finishes use 59" flex hose)
- Optional extension kit
- Flow rates: showerhead \leq 1.8 max gpm, handshower \leq 1.8 max gpm
- ADA

SHOWER
 Thermostatic Rough Valve
G-8006



Information

- 12.9 gpm @ 60 psi
- 3/4" universal inlets
- Built-in service stops
- Stacking outlet feature
- Complete serviceability from front of all units
- Supplied with protective plastic cover
- CalGreen compliant dependent on functions

Finishes

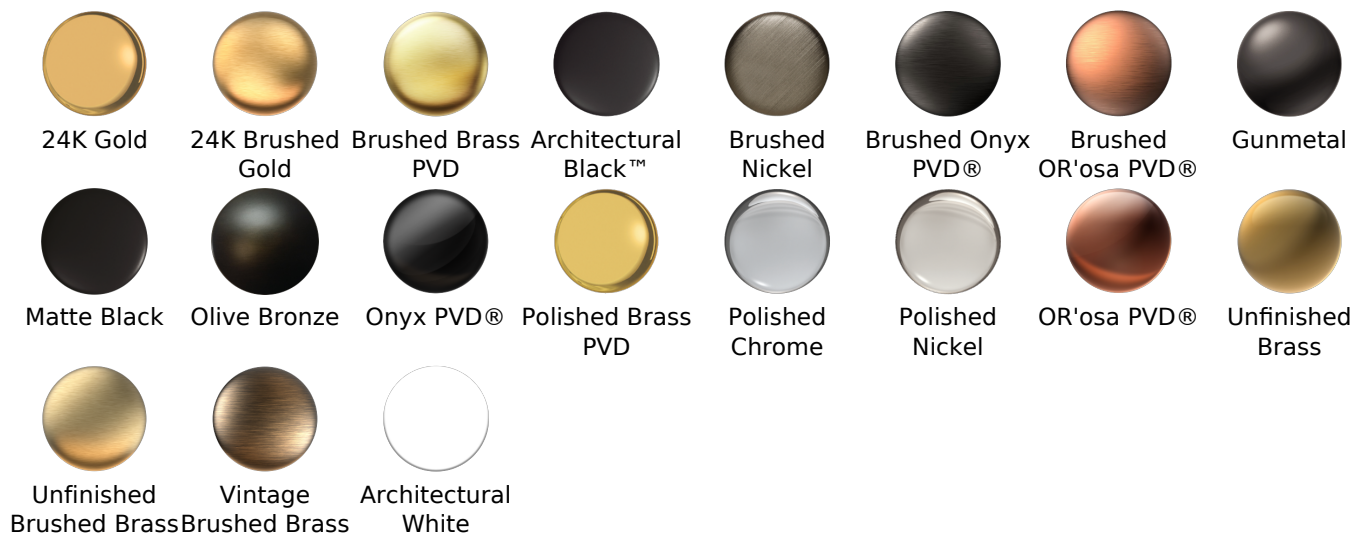

G-8006

M-Series

3/4" Concealed Thermostatic Rough Valve

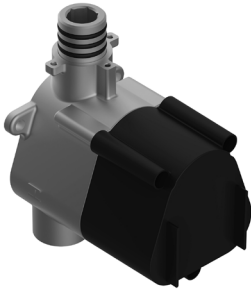

Product Features

- 12.9 gpm @ 60 psi
- 3/4" universal inlets
- Built-in service stops
- Stacking outlet feature
- Complete serviceability from front of all units
- Supplied with protective plastic cover
- CalGreen compliant dependent on functions

Code Compliance

- CALGreen

Warranty

- Limited lifetime warranty

For complete warranty information go to www.graff-faucets.com/en/info/faqs

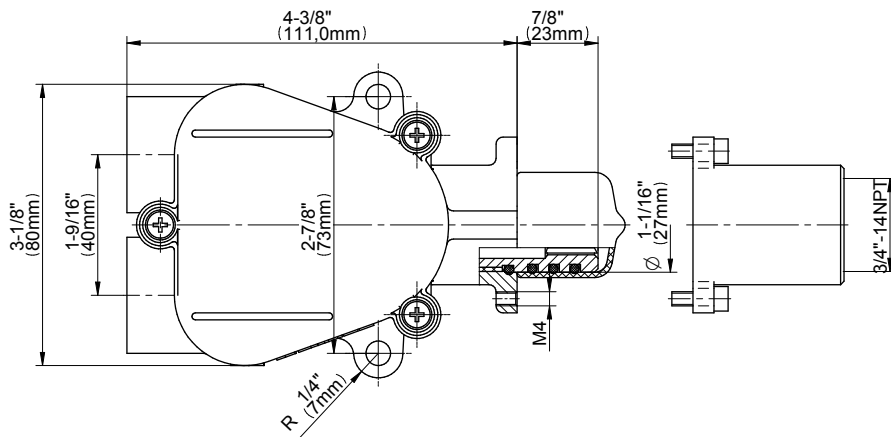
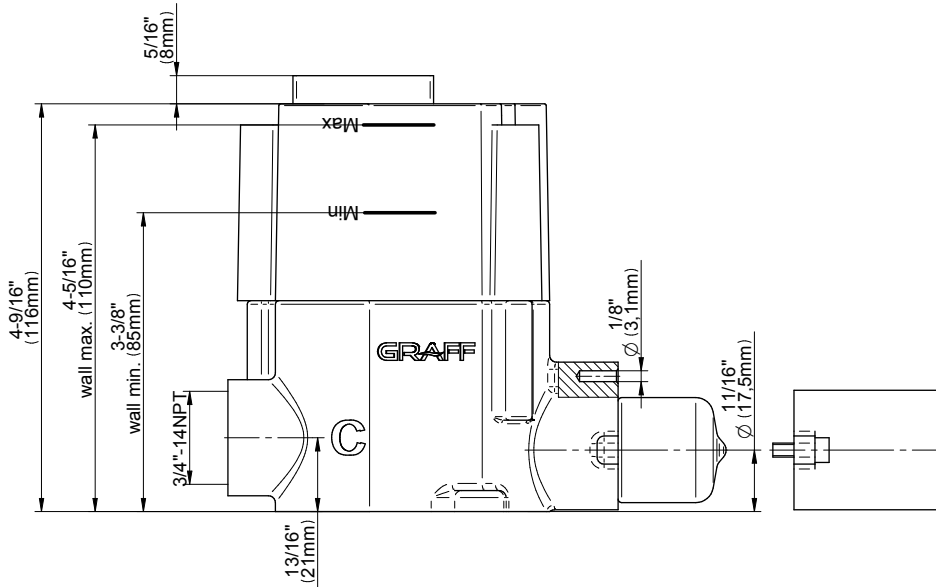

The measurements shown are for reference only. Products and specifications shown are subject to change without notice. Revised 3/2016.

www.graff-faucets.com | phone: 800-954-4723



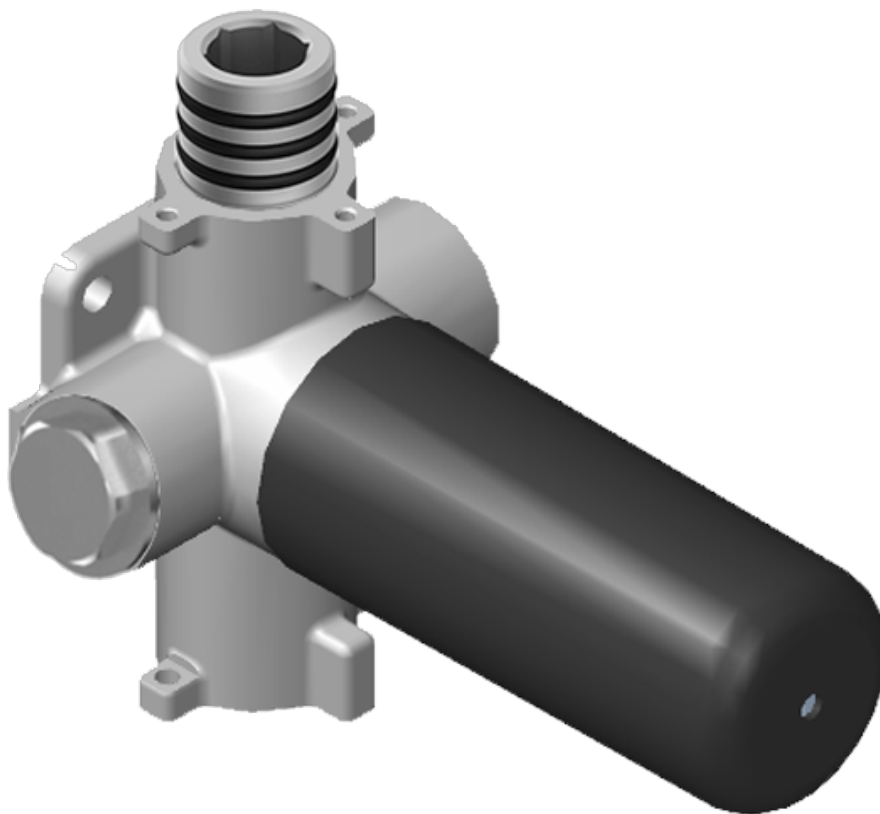











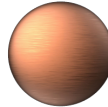

SHOWER
 Stop/Volume Control Valve with
 Pass Through
G-8076



Information

- 12.3 gpm @ 60 psi
- 3/4" universal inlets/outlets with female threads
- Stacking inlet and pass-through port feature
- Supplied with protective plastic cover
- CalGreen compliant dependent on functions

Finishes

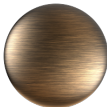
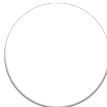
							
24K Gold	24K Brushed Gold	Brushed Brass PVD	Architectural Black™	Brushed Nickel	Brushed Onyx PVD®	Brushed OR'osa PVD®	Gunmetal
							
Matte Black	Olive Bronze	Onyx PVD®	Polished Brass PVD	Polished Chrome	Polished Nickel	OR'osa PVD®	Unfinished Brass
							
Unfinished Brushed Brass	Vintage Brushed Brass	Architectural White					

G-8076

M-Series

Stop/Volume Control Rough Valve with Pass-Through

GRAFF[®]
CUTTING EDGE DESIGN

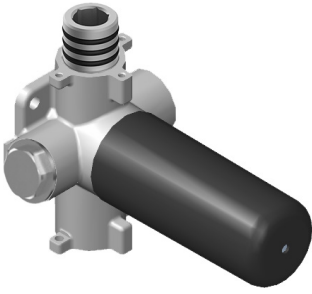

Product Features

- 13.2 gpm @ 60 psi
- 3/4" universal inlets/outlets with female threads
- Stacking inlet and pass-through port feature
- Supplied with protective plastic cover
- CalGreen compliant dependent on functions

Code Compliance

- CALGreen

Warranty

- Limited lifetime warranty

For complete warranty information go to www.graff-faucets.com/en/info/faqs

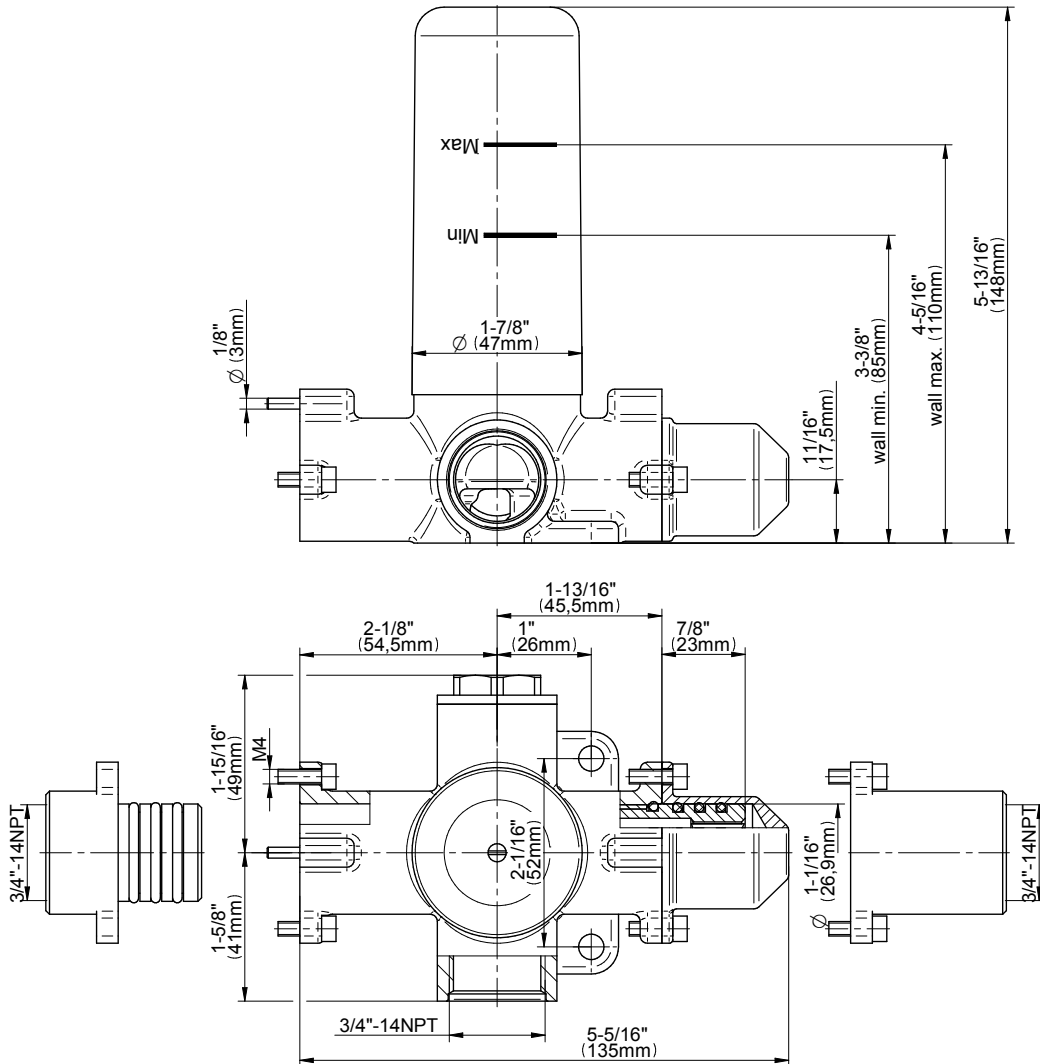

The measurements shown are for reference only. Products and specifications shown are subject to change without notice. Revised 3/2016.

www.graff-faucets.com | phone: 800-954-4723

SHOWER
 Finezza DUE Thermostatic 3-Hole
 Trim Plate and Handle
G-8178-C15E0-T

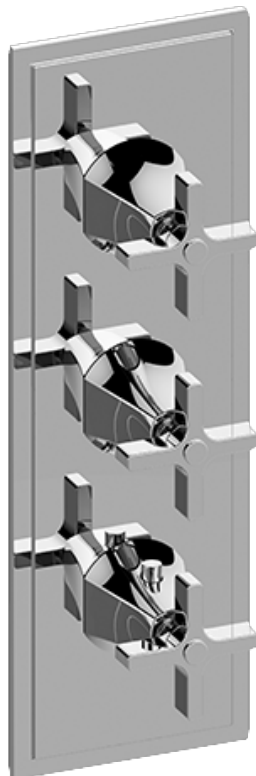

Information

- Three metal handles
- Decorative trim plate
- Use with G-8006 and G-8076 or G-8077 or G-8052 or G-8053 thermostatic rough valves
- To complete package, you must order rough valves

Finishes

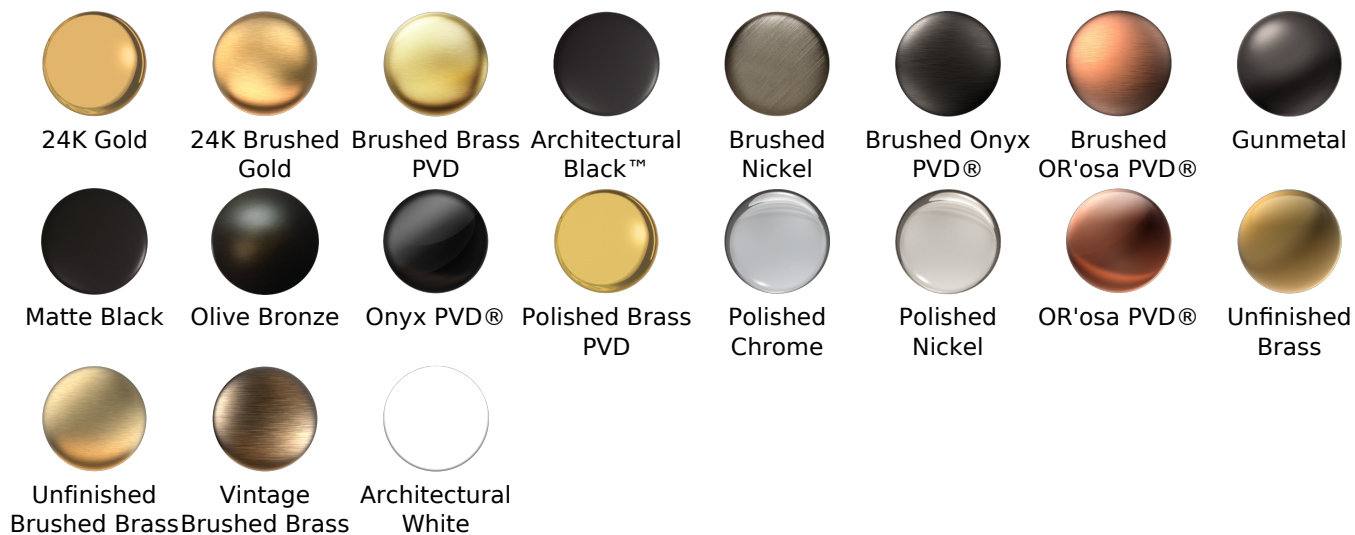

G-8178-C15E0-T

Finezza DUE Collection

Thermostatic 3-Hole Trim Plate and Handle

GRAFF[®]
CUTTING EDGE DESIGN



Product Features

- Three metal handles
- Decorative trim plate
- Use with G-8006 and G-8076 or G-8077 or G-8052 or G-8053 thermostatic rough valves
- To complete package, you must order rough valves

Available Finishes

- Polished Chrome
G-8178-C15E0-PC-T
- Brushed Nickel
G-8178-C15E0-BNi-T
- Polished Nickel
G-8178-C15E0-PN-T
- Olive Bronze™
G-8178-C15E0-OB-T

Warranty

- Limited lifetime warranty

For complete warranty information go to: www.graff-faucets.com/en/info/faqs

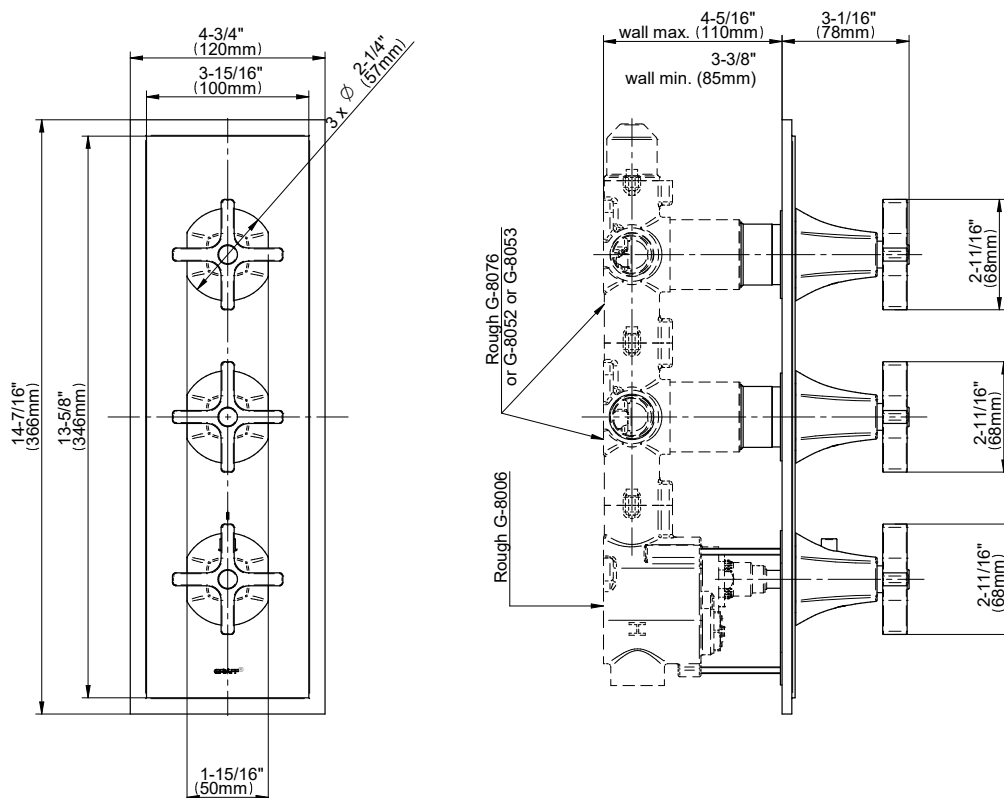

The measurements shown are for reference only. Products and specifications shown are subject to change without notice. Revised 5/2017













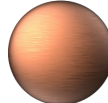

www.graff-faucets.com | phone: 800-954-4723



Information

- 126 no-clog, easy-clean rubber spray nozzles
- Recommended use with ceiling shower arm
- Recommended for use at no more than 10 degrees tilt
- Showerhead flow rate ≤ 1.8 max gpm
- CALGreen

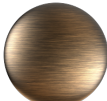
Finishes

							
24K Gold	24K Brushed Gold	Brushed Brass PVD	Architectural Black™	Brushed Nickel	Brushed Onyx PVD®	Brushed OR'osa PVD®	Gunmetal
							
Matte Black	Olive Bronze	Onyx PVD®	Polished Brass PVD	Polished Chrome	Polished Nickel	OR'osa PVD®	Unfinished Brass
							
Unfinished Brushed Brass	Vintage Brushed Brass	Architectural White					

G-8406

Finezza Collection
9" Rain Showerhead

GRAFF[®]
CUTTING EDGE DESIGN

Product Features

- Sunflower shape
- 126 no-clog, easy-clean rubber spray nozzles
- Showerhead flow rate < 1.8 max gpm

Available Finishes

- Polished Chrome
G-8406-PC
- Brushed Nickel
G-8406-BNi
- Polished Nickel
G-8406-PN
- Unfinished Brass*
G-8406-UB*
- Olive Bronze
G-8406-OB*
- Gold*
G-8406-AU*
- Brushed Gold*
G-8406-BAU*

* Special order finish- call for availability



Code Compliance

- CALGreen

Warranty

- Limited lifetime warranty

For complete warranty information go to www.graff-designs.com/en-nam/warranty

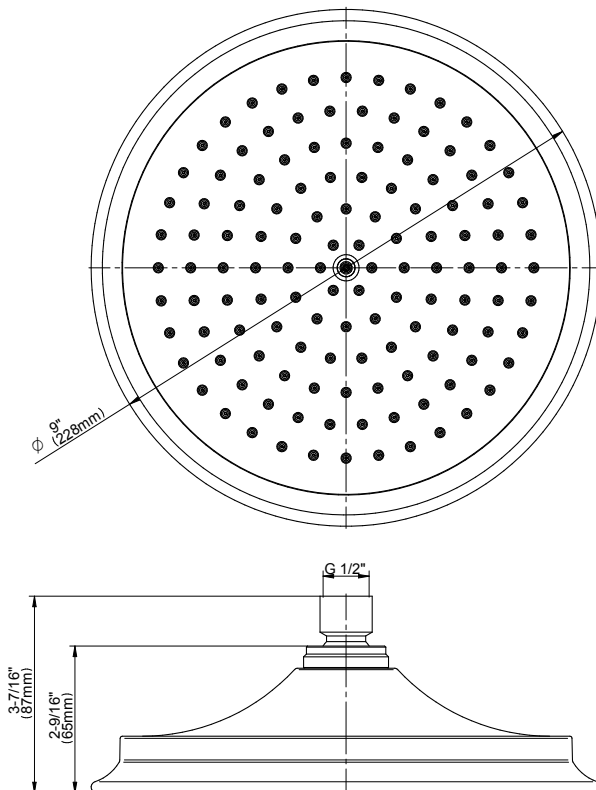

The measurements shown are for reference only. Products and specifications shown are subject to change without notice. Revised 12/2017

www.graff-designs.com | phone: 800-954-4723

SHOWER
 Finezza 12" Ceiling Shower Arm
G-8549

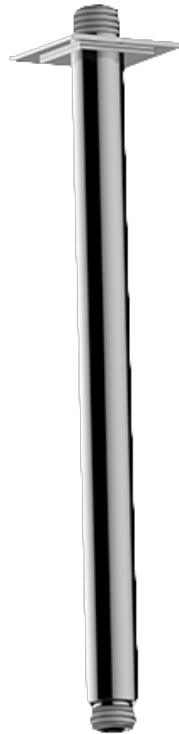

Information

- Includes arm and flange
- 1/2" NPT male thread inlet
- For use with all showerheads (especially G-8406)

Finishes

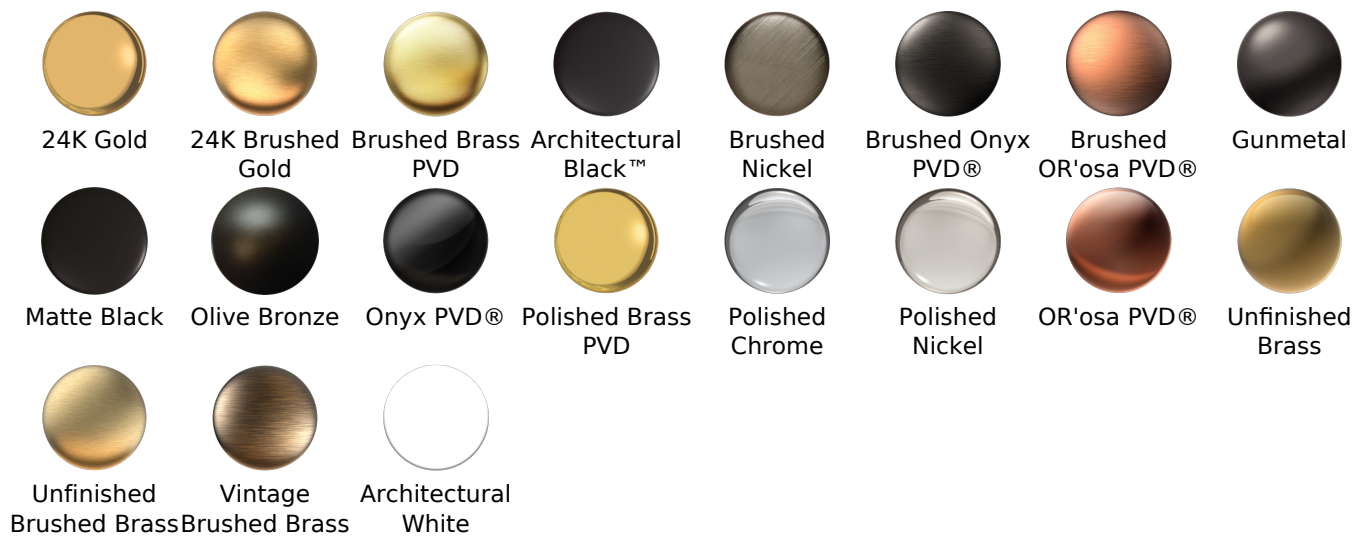

G-8549

Finezza Collection
12" Ceiling Shower Arm

GRAFF[®]
CUTTING EDGE DESIGN



Product Features

- Includes arm and flange
- 1/2" NPT male thread inlet
- For use with all showerheads (especially G-8406)

Available Finishes

- Polished Chrome
G-8549-PC
- Brushed Nickel
G-8549-BNi
- Polished Nickel
G-8549-PN
- Olive Bronze™
G-8549-OB

Code Compliance

- ADA

Warranty

- Limited lifetime warranty

For complete warranty information go to: www.graff-faucets.com/en/info/faqs

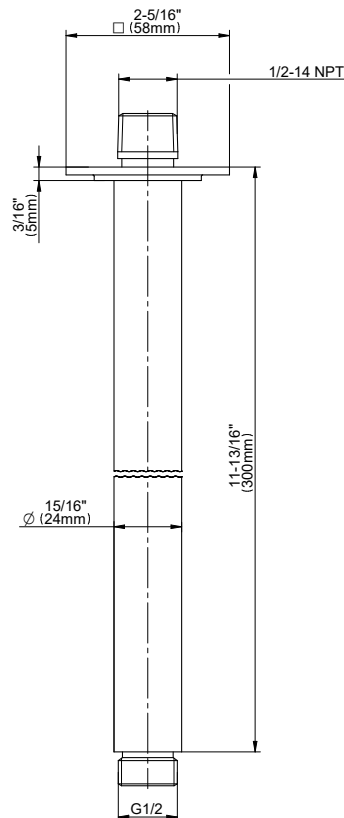

The measurements shown are for reference only. Products and specifications shown are subject to change without notice. Revised 05/2017

www.graff-faucets.com | phone: 800-954-4723



Information

- Brass spiral flexible hose with conical nut

Finishes

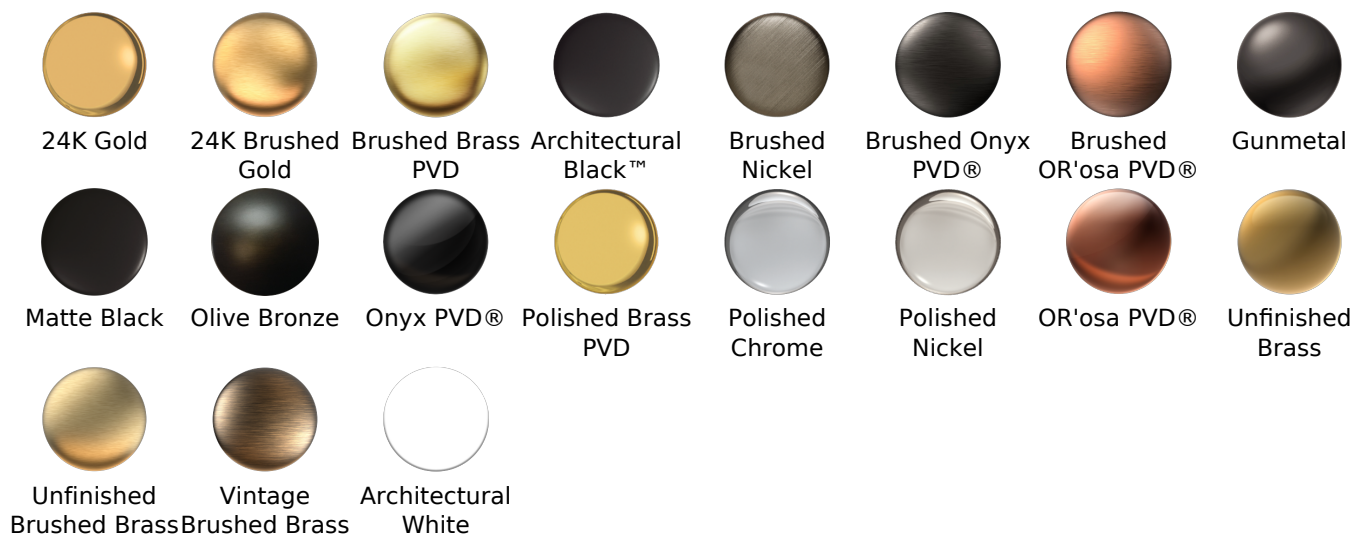



Product Features

- Brass spiral flexible hose with conical nut

Warranty

- Limited lifetime warranty

For complete warranty information go to www.graff-designs.com/en-nam/warranty

Available Finishes

- Polished Chrome
G-8605-PC
- Polished Nickel
G-8605-PN
- Brushed Nickel
G-8605-BNi
- Unfinished Brushed Brass*
G-8605-UBB*
- Unfinished Brass*
G-8605-UB*
- Matte Black*
G-8605-MBK*
- Architectural Black*
G-8605-BK*
- Architectural White*
G-8605-WT*
- Olive Brass*
G-8605-OB*
- Gunmetal*
G-8605-GM*
- Vintage Brushed Brass*
G-8605-VBB*
- Steelnox (Satin Nickel)
G-8605-SN
- 24K Brushed Gold*
G-8605-BAU*
- 24K Gold*
G-8605-AU*
- Gunmetal Distressed*
G-8605-GMD*

* Special order finish- call for availability





Information

- 1/2" NPT male thread inlet

Finishes



G-8653

Finezza DUE Collection
Finezza DUE Wall Supply Elbow



Product Features

- 1/2" NPT male thread inlet



Available Finishes

- Polished Chrome
G-8653-PC
- Brushed Nickel
G-8653-BNi
- Polished Nickel
G-8653-PN
- Olive Bronze
G-8653-OB
- Unfinished Brass*
G-8653-UB*
- Gold*
G-8653-AU*
- Brushed Gold*
G-8653-BAU*

* Special order finish- call for availability

Warranty

- Limited lifetime warranty

For complete warranty information go to <https://www.graff-faucets.com/en/info/faqs>

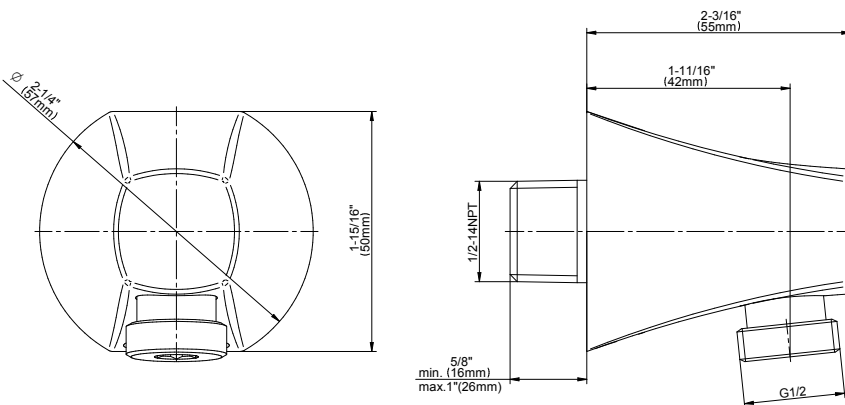

The measurements shown are for reference only. Products and specifications shown are subject to change without notice. Revised 5/2018.

www.graff-designs.com | phone: 800-954-4723

SHOWER
 Finezza DUE Wall-Mounted Slide
 Bar
G-8661



Information

- 22" wall-mounted slide bar
- Adjustable bracket fits all hoses with conical nut

Finishes



G-8661

Finezza DUE Collection

Finezza DUE Wall-Mounted Slide Bar

GRAFF®



Product Features

- 22" wall-mounted slide bar
- Adjustable bracket fits all hoses with conical nut

Available Finishes

- Polished Chrome
G-8661-PC
- Brushed Nickel
G-8661-BNi
- Polished Nickel
G-8661-PN
- Olive Bronze
G-8661-OB
- Unfinished Brass*
G-8661-UB*
- Gold*
G-8661-AU*
- Brushed Gold*
G-8661-BAU*

* Special order finish- call for availability

Warranty

- Limited lifetime warranty

For complete warranty information go to <https://www.graff-faucets.com/en/info/faqs>

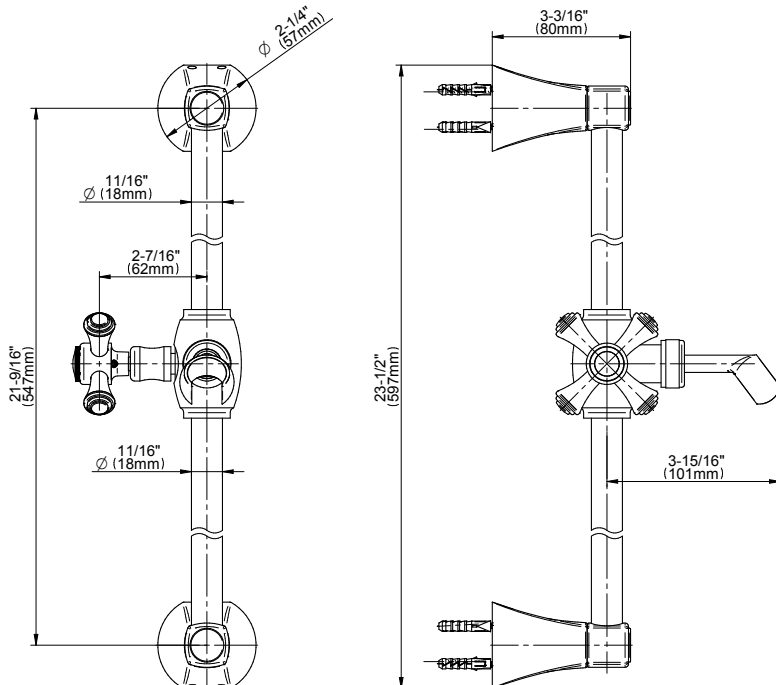

The measurements shown are for reference only. Products and specifications shown are subject to change without notice. Revised 5/2018.

















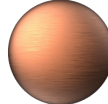

www.graff-designs.com | phone: 800-954-4723



Information

- Solid brass construction
- All-metal handle
- Shower hose not included
- Includes internal backflow preventer
- Handshower flow rate ≤ 1.8 max gpm
- CALGreen

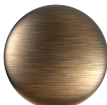
Finishes

							
24K Gold	24K Brushed Gold	Brushed Brass PVD	Architectural Black™	Brushed Nickel	Brushed Onyx PVD®	Brushed OR'osa PVD®	Gunmetal
							
Matte Black	Olive Bronze	Onyx PVD®	Polished Brass PVD	Polished Chrome	Polished Nickel	OR'osa PVD®	Unfinished Brass
							
Unfinished Brushed Brass	Vintage Brushed Brass	Architectural White					

G-8724

Finezza Collection
Finezza Handshower

GRAFF®



Product Features

- Solid brass construction
- Smooth, all-metal handle
- Shower hose not included
- Handshower flow rate ≤ 1.5 max gpm
- Includes internal backflow preventer

Available Finishes

- Polished Chrome
G-8724-PC
- Brushed Nickel
G-8724-BNi
- Polished Nickel
G-8724-PN
- Olive Bronze
G-8724-OB
- Unfinished Brass*
G-8724-UB*
- Gold*
G-8724-AU*
- Brushed Gold*
G-8724-BAU*

* Special order finish- call for availability

Warranty

- Limited lifetime warranty

For complete warranty information go to <https://www.graff-faucets.com/en/info/faqs>

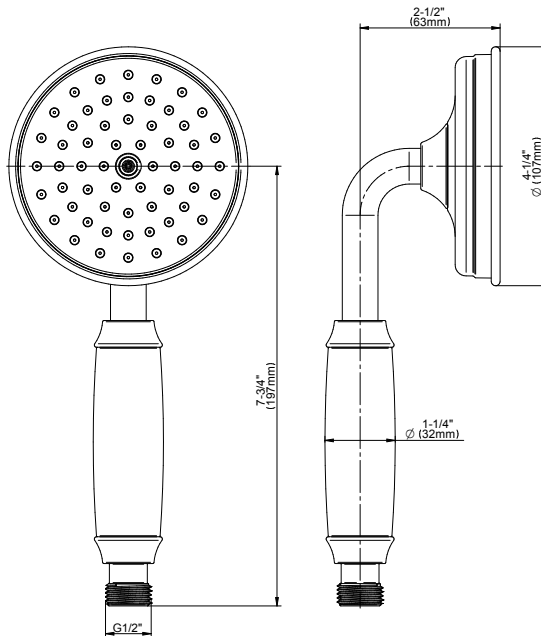

The measurements shown are for reference only. Products and specifications shown are subject to change without notice. Revised 5/2018.

www.graff-designs.com | phone: 800-954-4723