

BATHROOM  
Sade Floor-Mounted Tub Filler  
**G-1854-LM36N**

---

**GRAFF**<sup>®</sup>



### **Information**

- Floor-mounted installation
- Aerated Flow Rate ~9 gpm @45 psi
- Handshower flow rate  $\leq 1.5$  max gpm
- 9-7/8" spout reach
- 36-5/8" to 39-3/4" total height
- Includes handshower with 59" spiral flexible hose
- Optional in-line pressure balancing valve

**G-1854-LM36N**  
 Sade Collection  
 Floor-Mounted Tub Filler



**Product Features**

- Floor-mounted installation
- Aerated flow rate ~9gpm @45 psi
- Handshower flow rate ≤ 1.5 max gpm
- 9-7/8" spout reach
- 36-5/8" to 39-3/4" total height
- Includes handshower with 59" spiral flexible hose
- Optional in-line pressure balancing valve

**Available Finishes**

- Polished Chrome  
G-1854-LM36N-PC
- Polished Nickel  
G-1854-LM36N-PN
- Unfinished Brass\*  
G-1854-LM36N-UB\*
- Olive Bronze  
G-1854-LM36N-OB
- Steelnx  
G-1854-LM36N-SN
- Gold\*  
G-1854-LM36N-AU\*
- Brushed Gold\*  
G-1854-LM36N-BAU\*

\* Special order finish- call for availability

**Code Compliance**

- ADA

**Warranty**

- Limited lifetime warranty

For complete warranty information go to [www.graff-designs.com/en-nam/warranty](http://www.graff-designs.com/en-nam/warranty)

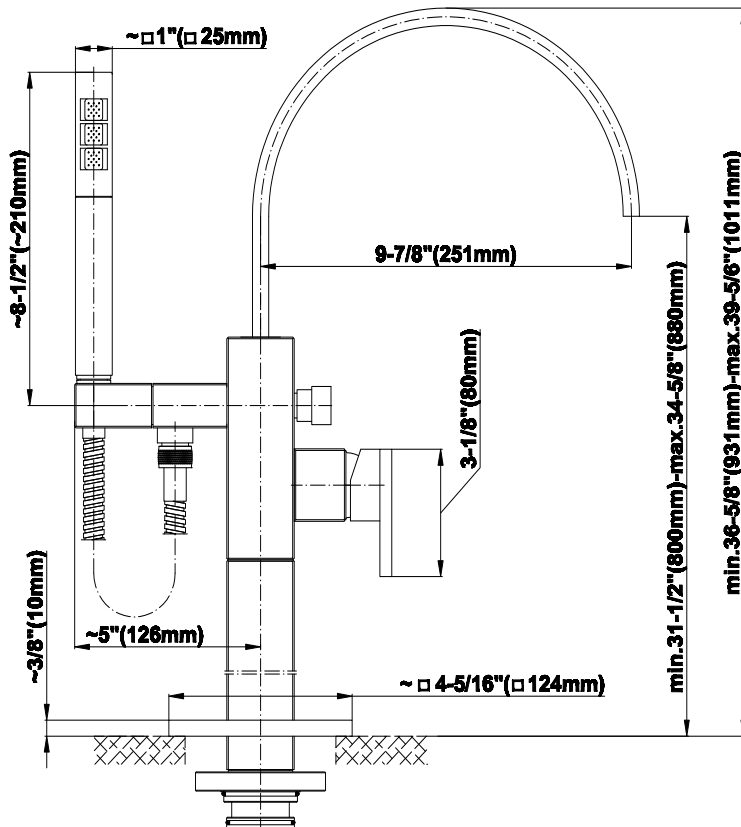

The measurements shown are for reference only. Products and specifications shown are subject to change without notice. Revised 11/2017

[www.graff-designs.com](http://www.graff-designs.com) | phone: 800-954-4723

BATHROOM  
Spout Connection Rough  
**G-1045**

**GRAFF®**



**Finishes**



24K Gold



24K Brushed  
Gold



Architectural  
Black™



Matte Black



Olive Bronze



Polished  
Chrome



Polished  
Nickel



Steelnox®  
(Satin Nickel)

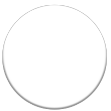

Architectural  
White

# G-1045

## Spout Connection Rough



### Product Features

- Mud guard displays minimum and maximum floor depth
- Rough can be installed in any orientation making it convenient to route pipes to the rough
- Trim can be rotated 360 degrees in any directions
- Averages 10 GPM with most trim

### Warranty

- Limited lifetime warranty

For complete warranty information go to <http://www.graff-faucets.com/en/info/faqs>

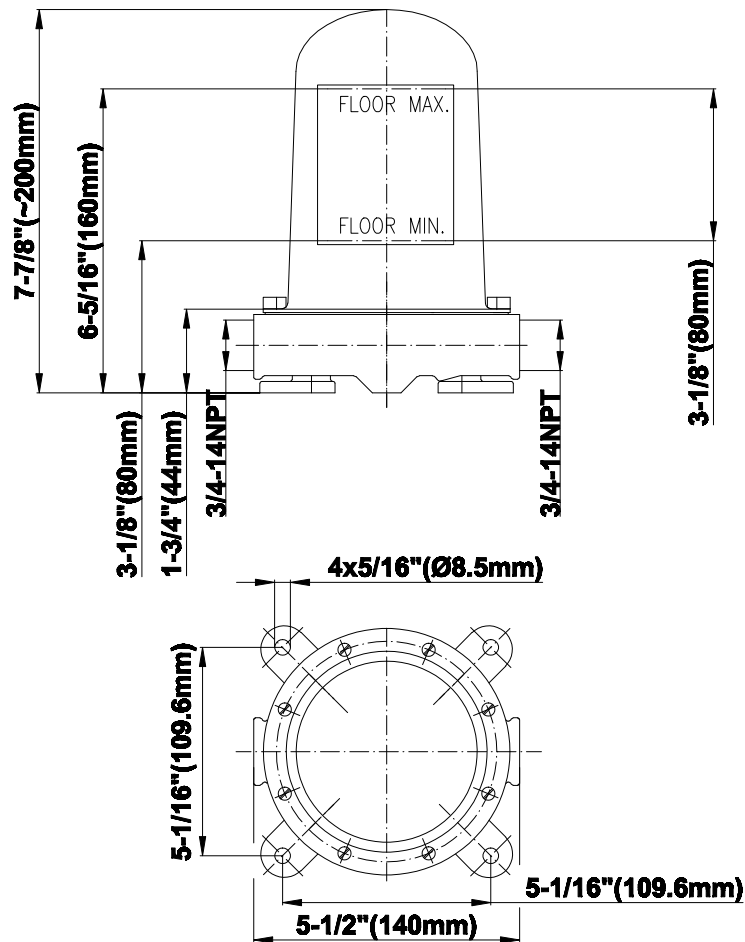

BATHROOM  
Sade Floor-Mounted Tub Filler  
**G-1854-LM36N**

**GRAFF**<sup>®</sup>



### Information

- Floor-mounted installation
- Aerated Flow Rate ~9 gpm @45 psi
- Handshower flow rate ≤1.5 max gpm
- 9-7/8" spout reach
- 36-5/8" to 39-3/4" total height
- Includes handshower with 59" spiral flexible hose
- Optional in-line pressure balancing valve

### Finishes



24K Gold

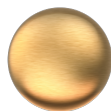

24K Brushed  
Gold



Architectural  
Black™



Matte Black

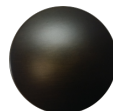

Olive Bronze



Polished  
Chrome



Polished  
Nickel



Steelnox<sup>®</sup>  
(Satin Nickel)

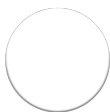

Architectural  
White



### Product Features

- Floor-mounted installation
- Aerated flow rate ~9gpm @45 psi
- Handshower flow rate ≤ 1.5 max gpm
- 9-7/8" spout reach
- 36-5/8" to 39-3/4" total height
- Includes handshower with 59" spiral flexible hose
- Optional in-line pressure balancing valve

### Available Finishes

- Polished Chrome  
G-1854-LM36N-PC
- Polished Nickel  
G-1854-LM36N-PN
- Unfinished Brass\*  
G-1854-LM36N-UB\*
- Olive Bronze  
G-1854-LM36N-OB
- Steelnox  
G-1854-LM36N-SN
- Gold\*  
G-1854-LM36N-AU\*
- Brushed Gold\*  
G-1854-LM36N-BAU\*

\* Special order finish- call for availability

### Code Compliance

- ADA

### Warranty

- Limited lifetime warranty

For complete warranty information go to [www.graff-designs.com/en-nam/warranty](http://www.graff-designs.com/en-nam/warranty)

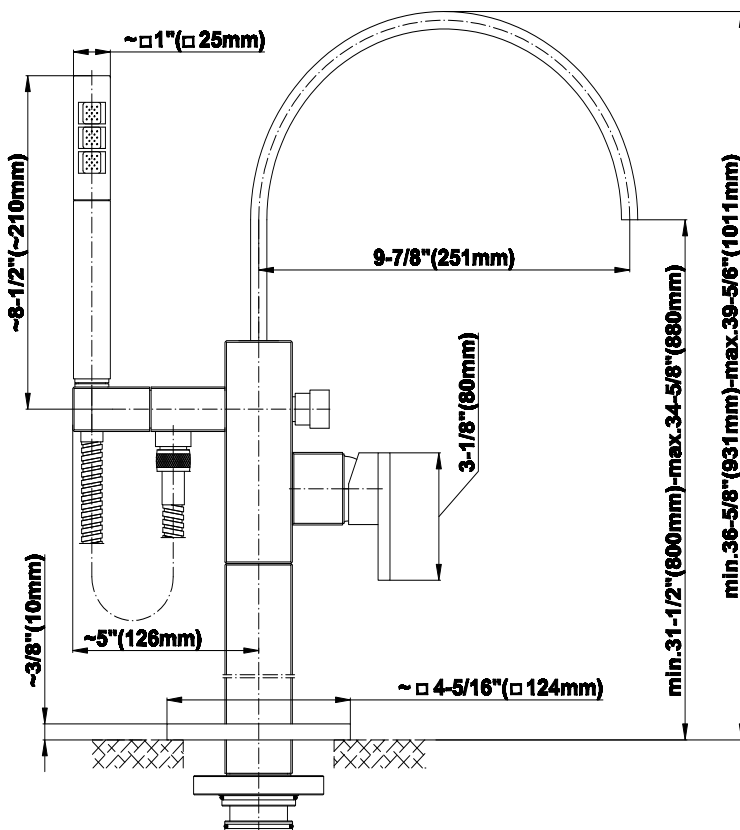

The measurements shown are for reference only. Products and specifications shown are subject to change without notice. Revised 11/2017

[www.graff-designs.com](http://www.graff-designs.com) | phone: 800-954-4723