

BATHROOM
Sade Floor-Mounted Tub Filler
w/Wall-Mounted Handshower &
Diverter
G-1853-C14U

GRAFF®



Information

- Floor-mounted spout installation
- Aerated Flow Rate ~10.6 gpm @45 psi
- Handshower flow rate ≤ 1.5 max gpm
- 9-7/8" spout reach
- 37"- 40" spout height
- Optional in-line pressure balancing valve
- Wall-mounted handle installation

BATHROOM
Sade/Targa/Luna Tub Handle Set -
Wall-Mounted
C14U-BS

GRAFF®

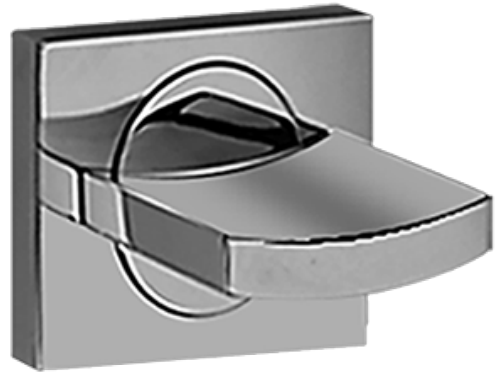
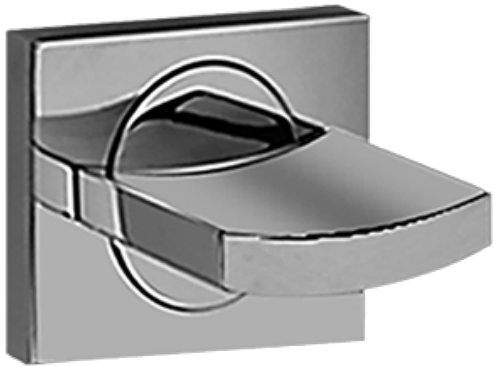

Finishes



24K Gold



24K Brushed
Gold



Architectural
Black™



Matte Black

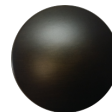

Olive Bronze



Polished
Chrome



Polished
Nickel



Steelnox®
(Satin Nickel)

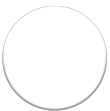

Architectural
White

C14U-BS, VS, WS

LUNA, SADE, TARGA Series

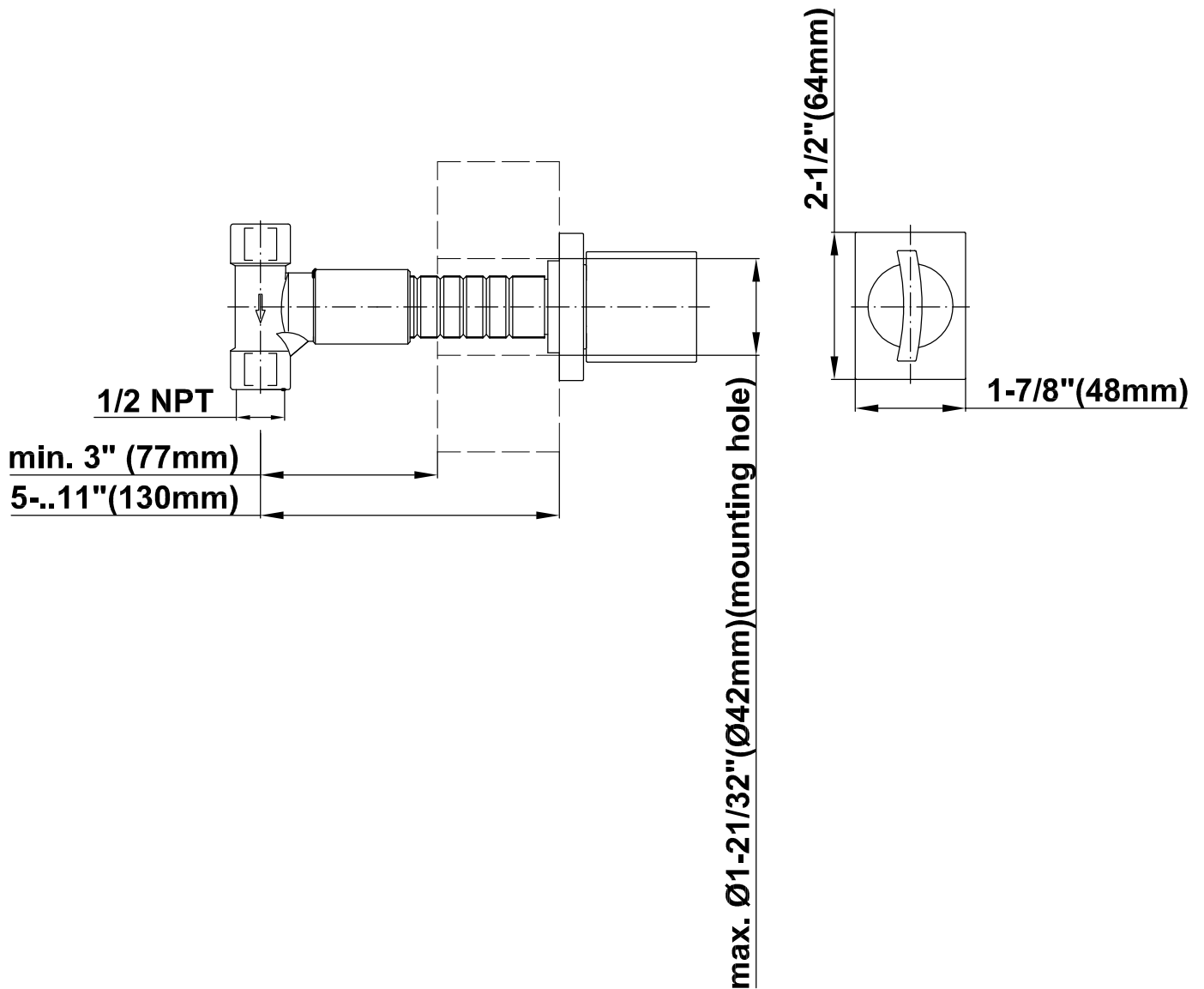

BATHROOM
Spout Connection Rough
G-1050

GRAFF®



Finishes



24K Gold



24K Brushed
Gold



Architectural
Black™



Matte Black

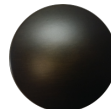

Olive Bronze



Polished
Chrome



Polished
Nickel



Steelnox®
(Satin Nickel)

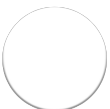

Architectural
White

G-1050

Rough

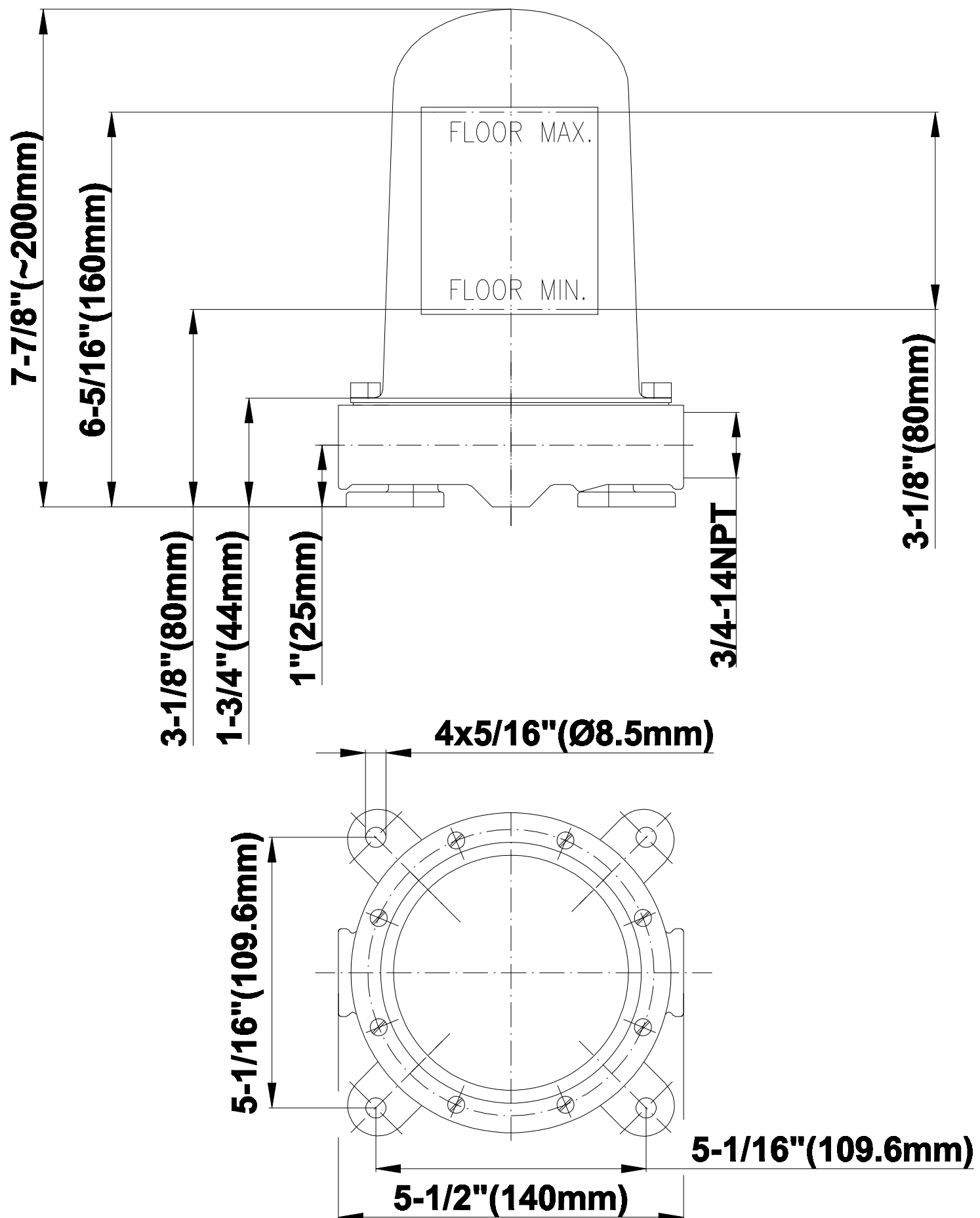

BATHROOM
Sade Floor-Mounted Tub Filler -
Spout Only
G-1852-T

GRAFF®

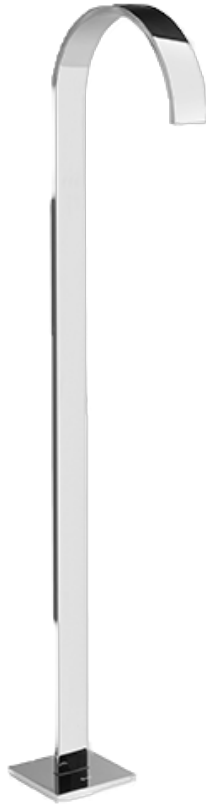

Information

- Floor-mounted spout installation
- Aerated Flow Rate ~10.6 gpm @45 psi
- 9-7/8" spout reach
- 37"- 40" ~spout height
- Optional in-line pressure balancing valve

Finishes



24K Gold



24K Brushed
Gold



Architectural
Black™



Matte Black

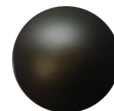

Olive Bronze



Polished
Chrome



Polished
Nickel



Steelnox®
(Satin Nickel)



Architectural
White

G-1852-T SPOUT

SADE Series

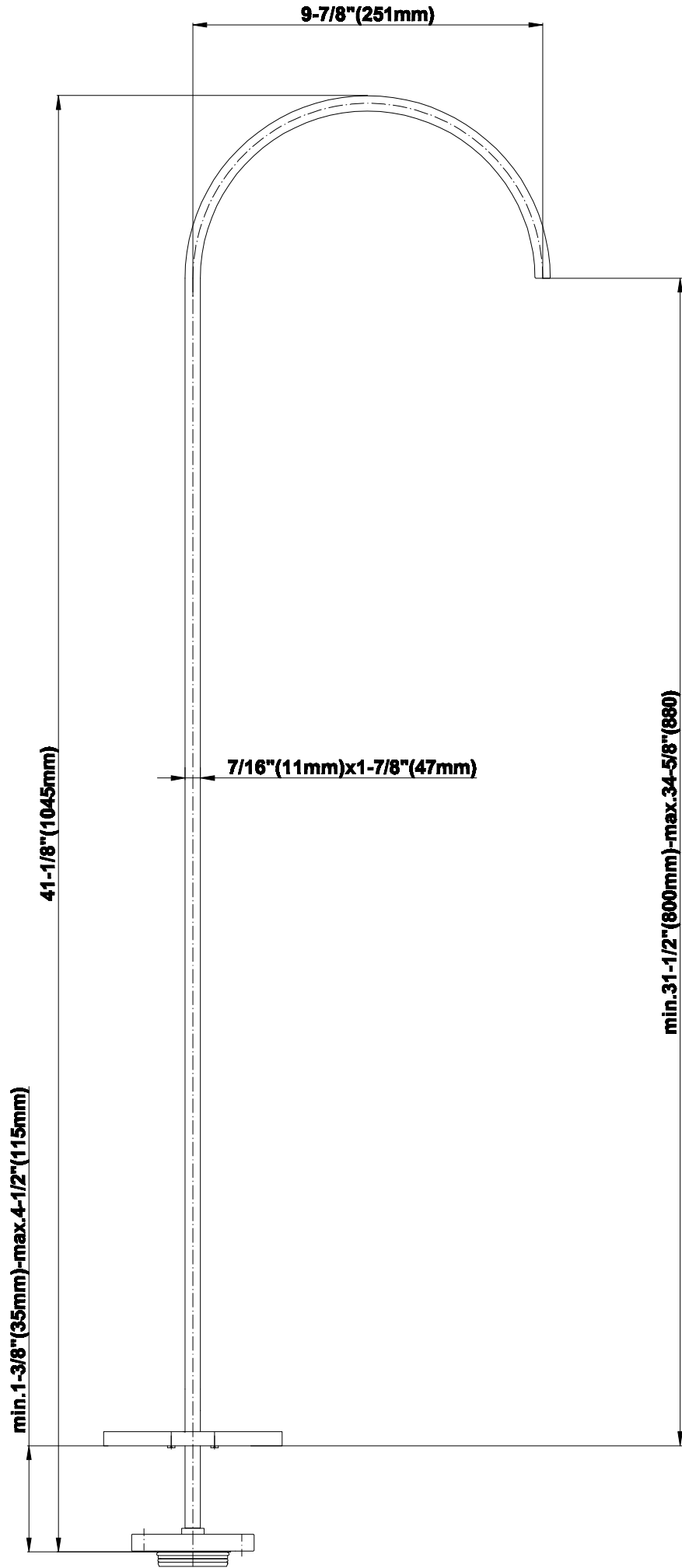

BATHROOM
Sade/Targa/Luna Wall-Mounted
Handshower & Diverter
G-6056

GRAFF®



Information

- Wall-mounted Handshower and Diverter Flow Rate 2.1 gpm @ 60 psi

Finishes



24K Gold



24K Brushed
Gold



Architectural
Black™



Matte Black

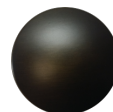

Olive Bronze



Polished
Chrome



Polished
Nickel



Steelnox®
(Satin Nickel)



Architectural
White

G-6056

SADE, TARGA, LUNA Series

